

## Micropower Single Supply Rail-to-Rail Input-Output Op Amp

The EL8188 is a micropower operational amplifier optimized for single supply operation at 5V and can operate down to 2.4V.

The EL8188 draws minimal supply current while meeting excellent DC-accuracy noise and output drive specifications. Competing devices seriously degrade these parameters to achieve micropower supply current. Offset current, voltage and current noise, slew rate, and gain-bandwidth product are all two to ten times better than on previous micropower op amps.

The EL8188 can be operated from one lithium cell or two Ni-Cd batteries. The input range includes both positive and negative rail. The output swings to both rails.

### Ordering Information

PART NUMBER (BRAND)	PACKAGE	TAPE & REEL	PKG. DWG. #
EL8188IW-T7 (BBKA)	6-Pin SOT-23	7" (3K pcs)	MDP0038
EL8188IW-T7A (BBKA)	6-Pin SOT-23	7" (250 pcs)	MDP0038
EL8188ISZ (See Note)	8-Pin SO (Pb-free)	-	MDP0027
EL8188ISZ-T7 (See Note)	8-Pin SO (Pb-free)	7"	MDP0027
EL8188ISZ-T13 (See Note)	8-Pin SO (Pb-free)	13"	MDP0027

NOTE: Intersil Pb-free plus anneal products employ special Pb-free material sets; molding compounds/die attach materials and 100% matte tin plate termination finish, which are RoHS compliant and compatible with both SnPb and Pb-free soldering operations. Intersil Pb-free products are MSL classified at Pb-free peak reflow temperatures that meet or exceed the Pb-free requirements of IPC/JEDEC J STD-020.

### Features

- 50µA supply current
- 1mV typical offset voltage
- 0.5 NA input bias current
- 250kHz gain-bandwidth product
- 0.13V/µs slew rate
- Single supply operation down to 2.4V
- Rail-to-rail input and output
- Output sources and sinks 26mA load current
- Pb-Free plus anneal available (RoHS compliant)

### Applications

- Battery- or solar-powered systems
- 4mA to 25mA current loops
- Handheld consumer products
- Medical devices
- Thermocouple amplifiers
- Photodiode pre amps
- pH probe amplifiers
- Pressure sensor pre amp

### Pinouts

**EL8188  
(6-PIN SOT-23)  
TOP VIEW**

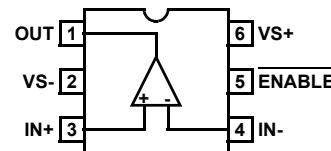

**EL8188  
(8-PIN SO)  
TOP VIEW**

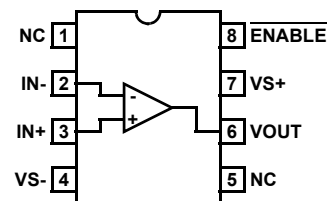

**Absolute Maximum Ratings** ( $T_A = 25^\circ\text{C}$ )

Supply Voltage	5.5V	Output Short-Circuit Duration	Indefinite
Differential Input Current	5mA	Ambient Operating Temperature Range	-40°C to +85°C
Input Voltage	-0.5V to $V_S + 0.5V$	Storage Temperature Range	-65°C to +150°C
ESD	2kV		

*CAUTION: Stresses above those listed in "Absolute Maximum Ratings" may cause permanent damage to the device. This is a stress only rating and operation of the device at these or any other conditions above those indicated in the operational sections of this specification is not implied.*

*IMPORTANT NOTE: All parameters having Min/Max specifications are guaranteed. Typical values are for information purposes only. Unless otherwise noted, all tests are at the specified temperature and are pulsed tests, therefore:  $T_J = T_C = T_A$*

**Electrical Specifications**  $V_S = 5V, 0V, V_{CM} = 0.1V, V_O = 1.4V, T_A = 25^\circ\text{C}$  unless otherwise specified.

PARAMETER	DESCRIPTION	CONDITIONS	MIN	TYP	MAX	UNIT
$V_{OS}$	Input Offset Voltage			1	4	mV
$\frac{\Delta V_{OS}}{\Delta T}$	Input Offset Drift vs Temperature	EL8188IW		1.9		$\mu\text{V}/^\circ\text{C}$
		EL8188IS		1.1		$\mu\text{V}/^\circ\text{C}$
$I_B$	Input Bias Current			0.5	1	NA
$e_N$	Input Noise Voltage Density	$f_O = 1\text{kHz}$		35		$\text{nV}/\sqrt{\text{Hz}}$
CMIR	Input Voltage Range	Guaranteed by CMRR test	0		5	V
CMRR	Common-Mode Rejection Ratio	$V_{CM} = 0V$ to $5V$	80	100		dB
PSRR	Power Supply Rejection Ratio	$V_S = 3.3V$ to $5V$	80	100		dB
$A_{VOL}$	Large Signal Voltage Gain	$V_O = 0.5V$ to $4.5V, R_L = 100\text{k}\Omega$	100	400		$\text{V}/\text{mV}$
		$V_O = 0.5V$ to $4.5V, R_L = 1\text{k}\Omega$		15		$\text{V}/\text{mV}$
$V_{OUT}$	Maximum Output Voltage Swing	Output low, $R_L = 100\text{k}\Omega$		3	6	mV
		Output low, $R_L = 1\text{k}\Omega$		130	200	mV
		Output high, $R_L = 100\text{k}\Omega$	4.994	4.997		V
		Output high, $R_L = 1\text{k}\Omega$	4.8	4.88		V
SR	Slew Rate		0.09	0.13	0.17	$\text{V}/\mu\text{s}$
GBW	Gain Bandwidth Product	$f_O = 100\text{kHz}$		250		kHz
$I_{S,ON}$	Supply Current, Enabled		40	50	75	$\mu\text{A}$
$I_{S,OFF}$	Supply Current, Disabled			3	10	$\mu\text{A}$
$I_{O+}$	Short Circuit Output Current	$R_L = 10\Omega$	18	31		mA
$I_{O-}$	Short Circuit Output Current	$R_L = 10\Omega$	17	26		mA
$V_S$	Minimum Supply Voltage			2.2	2.4	V
$V_{INH}$	Enable Pin High Level				2	V
$V_{INL}$	Enable Pin Low Level		0.8			V
$I_{ENH}$	Enable Pin Input Current	$V_{EN} = 5V$	0.25	0.7	2	$\mu\text{A}$
$I_{ENL}$	Enable Pin Input Current	$V_{EN} = 0V$	-0.5	0	+0.5	$\mu\text{A}$

Typical Performance Curves

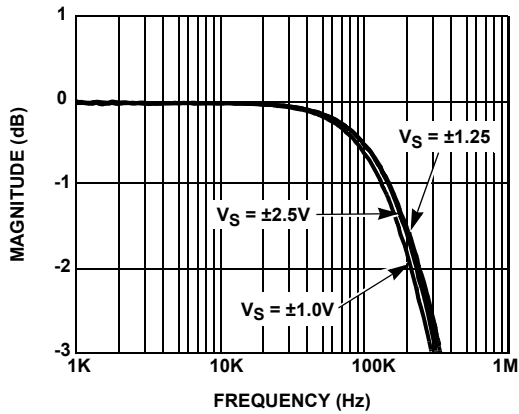

FIGURE 1. UNITY GAIN FREQUENCY RESPONSE vs SUPPLY VOLTAGE

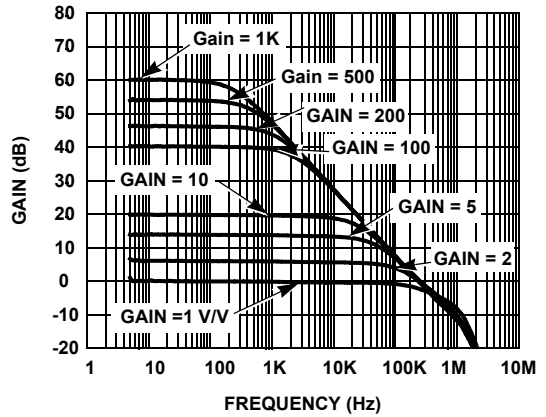

FIGURE 2. FREQUENCY RESPONSE vs CLOSED LOOP GAIN

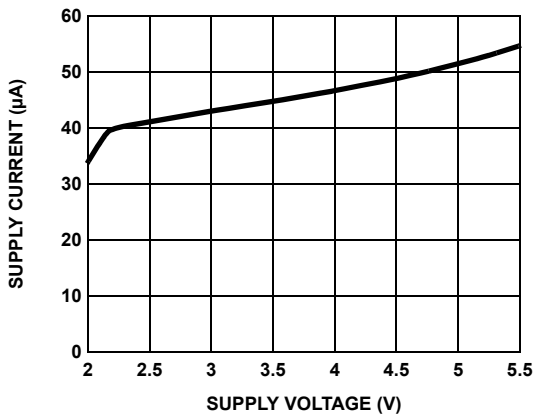

FIGURE 3. SUPPLY CURRENT vs SUPPLY VOLTAGE

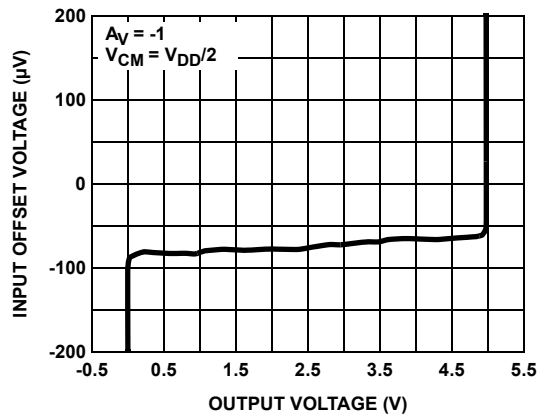

FIGURE 4. INPUT OFFSET VOLTAGE vs OUTPUT VOLTAGE

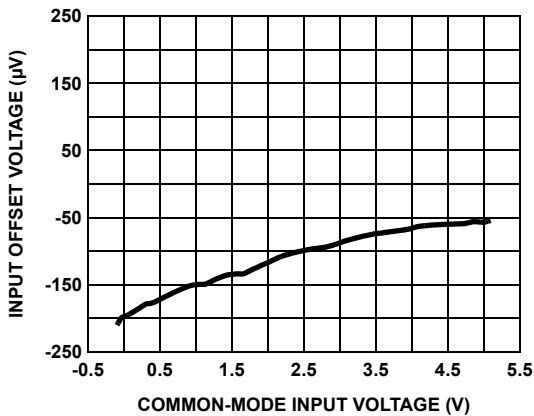

FIGURE 5. INPUT OFFSET VOLTAGE vs COMMON-MODE INPUT VOLTAGE

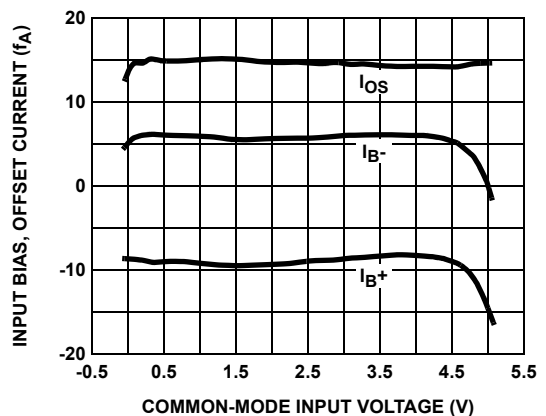

FIGURE 6. INPUT BIAS, OFFSET CURRENT vs COMMON-MODE INPUT VOLTAGE

Typical Performance Curves (Continued)

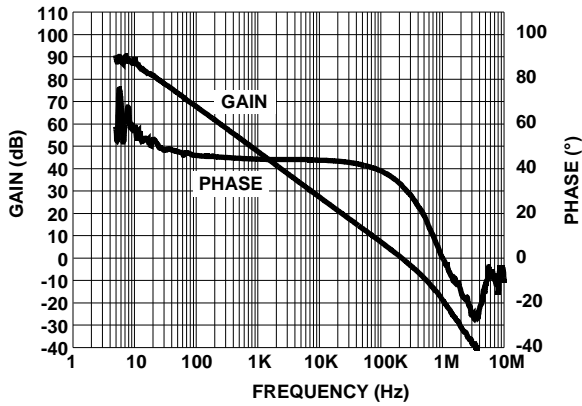

FIGURE 7. OPEN LOOP GAIN vs FREQUENCY @ 1kΩ

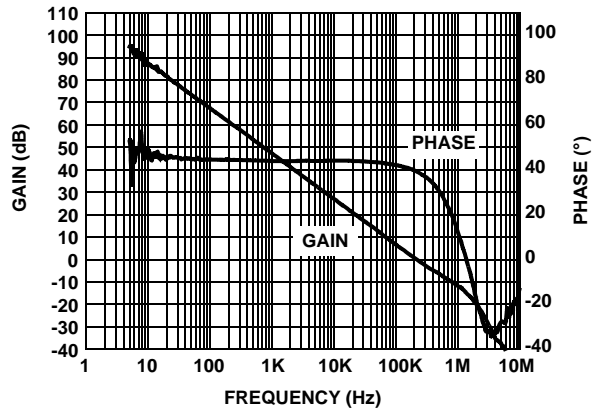

FIGURE 8. OPEN LOOP GAIN AND PHASE vs FREQUENCY @ 100kΩ

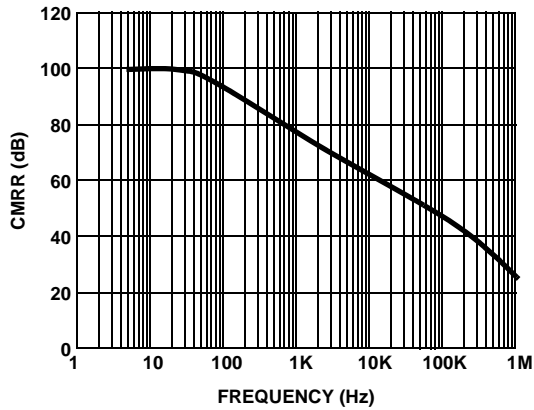

FIGURE 9. CMRR vs FREQUENCY

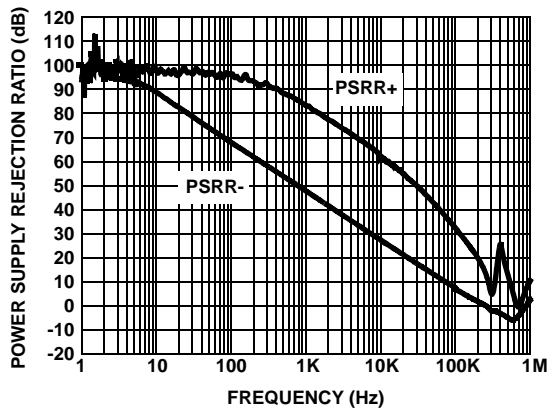

FIGURE 10. PSRR vs FREQUENCY

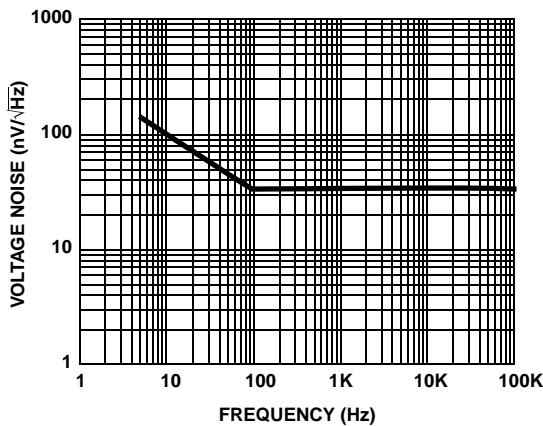

FIGURE 11. VOLTAGE NOISE

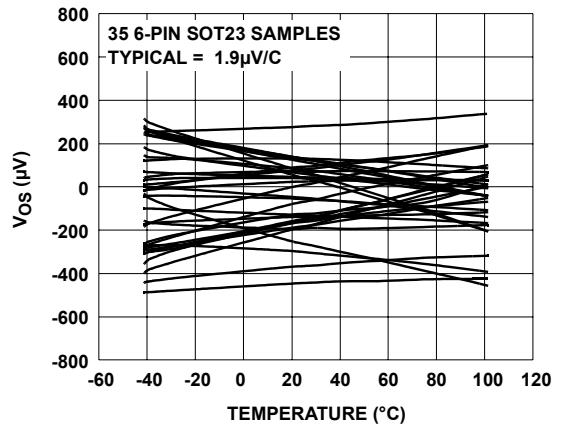

FIGURE 12. SOT  $V_{OS}$  vs TEMPERATURE ( $V_S = 5V$ )

Typical Performance Curves (Continued)

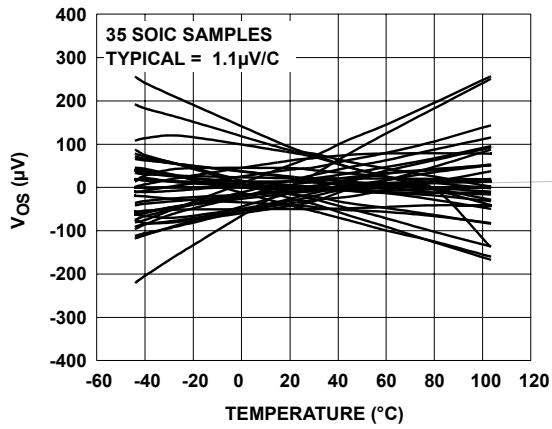

FIGURE 13. SOIC  $V_{OS}$  vs TEMPERATURE ( $V_S = 5V$ )

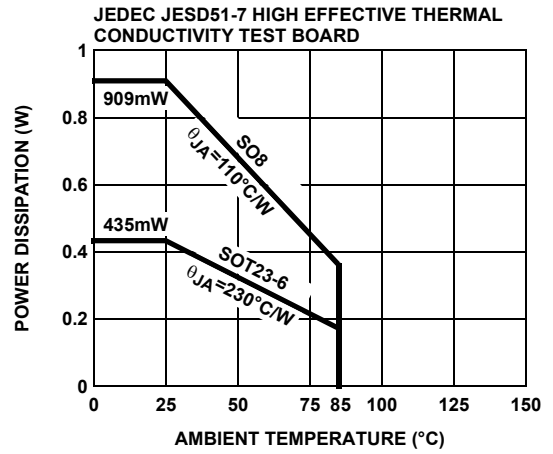

FIGURE 14. PACKAGE POWER DISSIPATION vs AMBIENT TEMPERATURE

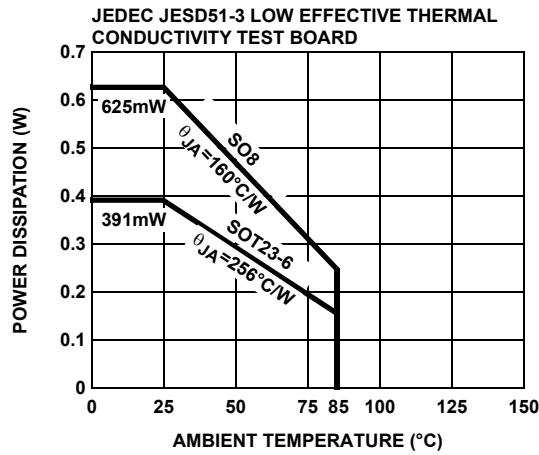

FIGURE 15. PACKAGE POWER DISSIPATION vs AMBIENT TEMPERATURE

## Applications Information

### Introduction

The EL8188 is a rail-to-rail input and output micro-power single supply operational amplifier with an enable feature. The device achieves rail-to-rail input and output operation and eliminates the concerns introduced by a conventional rail-to-rail I/O operational amplifier.

### Rail-to-Rail Input

The single PFET input stage of the EL8188 has an input common-mode voltage range that goes from negative supply to positive supply without introducing offset errors or degrading performance associated with a conventional rail-to-rail input operational amplifier. Many rail-to-rail input stages use dual differential input pairs, a long-tail PNP (or PFET) and an NPN (or NFET). Severe penalties have to be paid for this topology. As the input signal moves from one supply rail to another, the operational amplifier switches from one input pair to the other causing drastic changes in input offset voltage and an undesired change in magnitude and polarity of input offset current.

The EL8188 achieves input rail-to-rail performance without sacrificing important precision specifications and without degrading distortion performance. The EL8188's input offset voltage exhibits a smooth behavior throughout the entire common-mode input range.

### Rail-to-Rail Output

A pair of complementary MOSFET devices achieves rail-to-rail output swing. The NMOS sinks current to swing the output in the negative direction. The PMOS sources current to swing the output in the positive direction. The EL8188 with a  $100\text{k}\Omega$  load will swing to within  $3\text{mV}$  of the supply rails.

### Enable/Disable Feature

The EL8188 offers an EN pin. The active low enable pin disables the device when pulled up to at least  $2.2\text{V}$ . Upon disable the part consumes typically  $3\mu\text{A}$ , while the output is in a high impedance state. The EN also has an internal pull down. If left open, the EN pin will pull to negative rail and the device will be enabled by default. The high impedance at output during disable allows multiple EL8188's to be connected together as a MUX. The outputs are tied together in parallel and a channel can be selected by the EN pin.

## Typical Applications

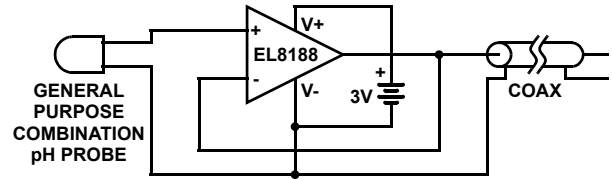

FIGURE 16. PH PROBE AMPLIFIER

A general-purpose combination pH probe has extremely high output impedance typically in the range of  $10\text{G}\Omega$  to  $12\text{G}\Omega$ . Low loss and expensive Teflon cables are often used to connect the PH probe to the meter electronics. The above circuit provides a low-cost alternative solution using the EL8188 and a low-cost coax cable. The EL8188 PMOS high impedance input senses the pH probe output signal and buffers it to drive the coax cable. Its rail-to-rail input nature also eliminates the need for a bias resistor network required by other amplifiers in the same application.

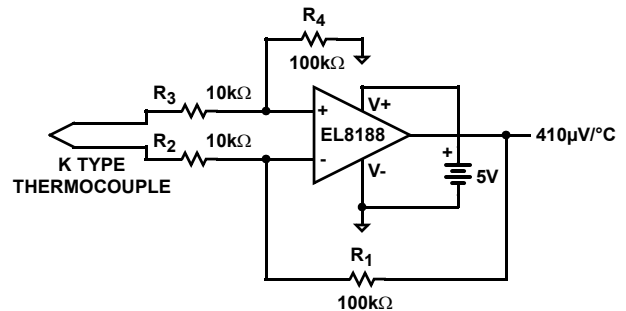
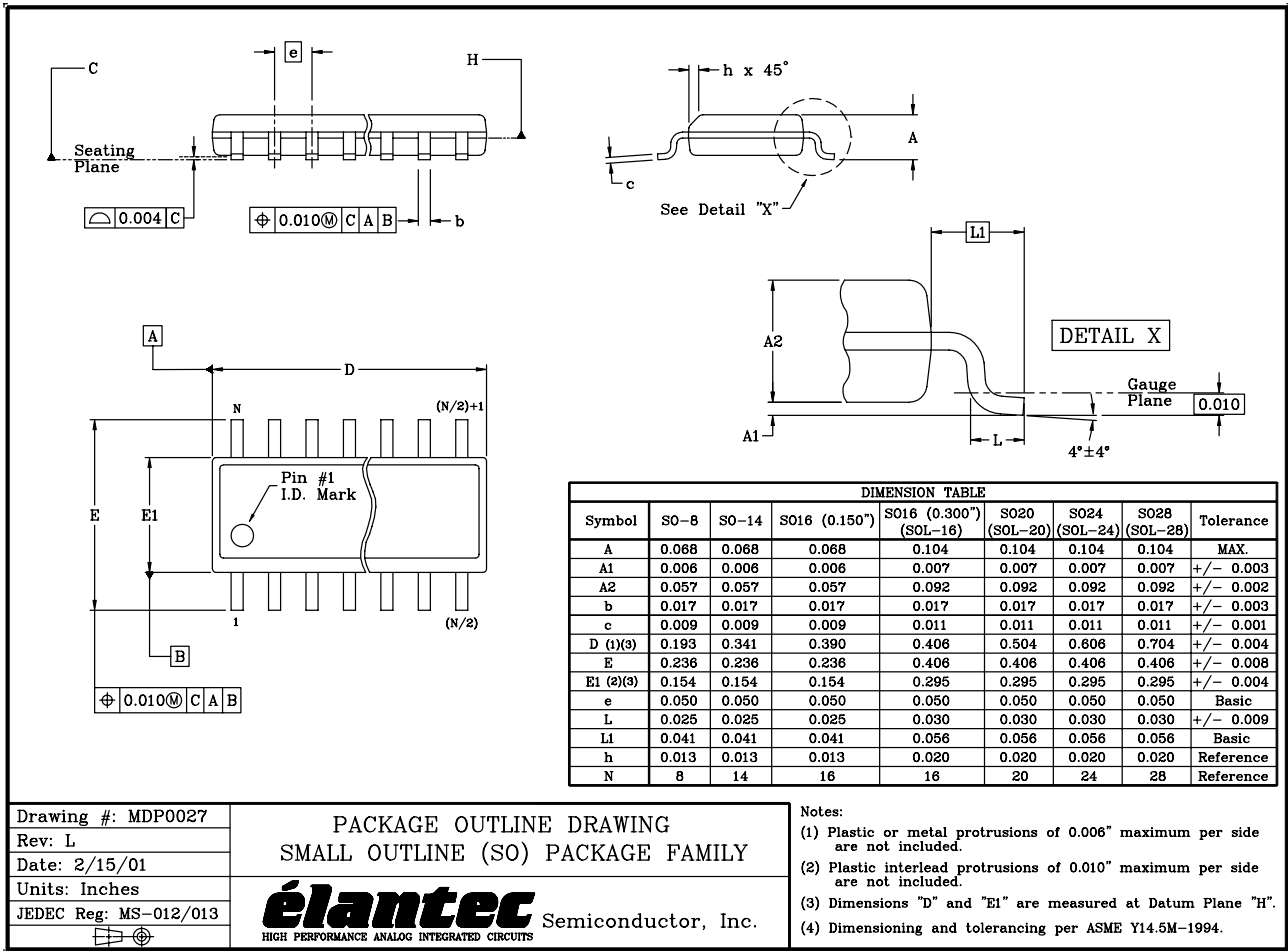

FIGURE 17. THERMOCOUPLE AMPLIFIER

Thermocouples are the most popular temperature-sensing device because of their low cost, interchangeability, and ability to measure a wide range of temperatures. The EL8188 is used to convert the differential thermocouple voltage into single-ended signal with 10X gain. The EL8188's rail-to-rail input characteristic allows the thermocouple to be biased at ground and the converter to run from a single 5V supply.

SO Package Outline Drawing



Drawing #: MDP0027  
 Rev: L  
 Date: 2/15/01  
 Units: Inches  
 JEDEC Reg: MS-012/013

PACKAGE OUTLINE DRAWING  
 SMALL OUTLINE (SO) PACKAGE FAMILY

**élantec** Semiconductor, Inc.  
 HIGH PERFORMANCE ANALOG INTEGRATED CIRCUITS

Notes:  
 (1) Plastic or metal protrusions of 0.006" maximum per side are not included.  
 (2) Plastic interlead protrusions of 0.010" maximum per side are not included.  
 (3) Dimensions "D" and "E1" are measured at Datum Plane "H".  
 (4) Dimensioning and tolerancing per ASME Y14.5M-1994.

SOT-23 Package Outline Drawing

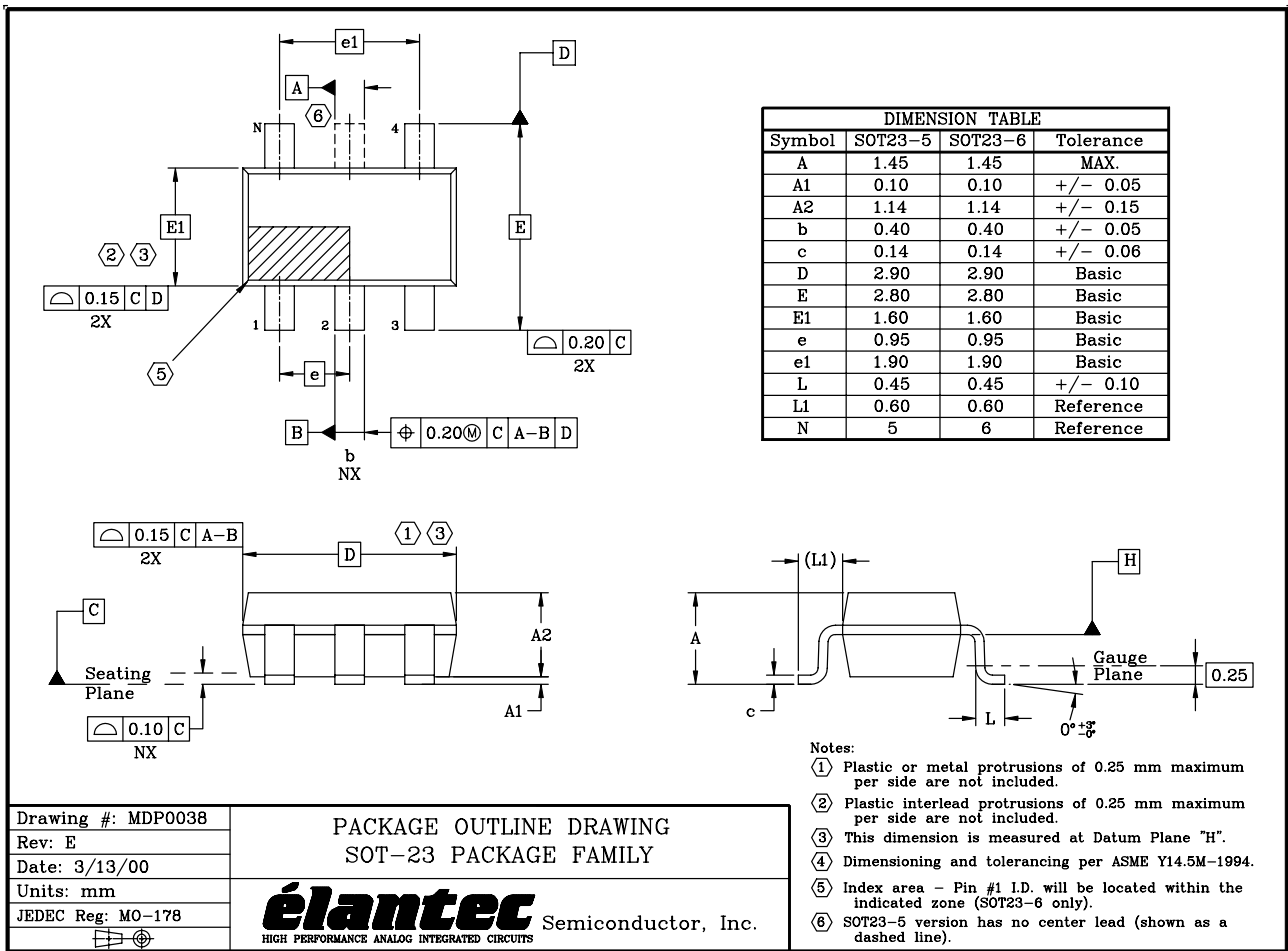

NOTE: The package drawing shown here may not be the latest version. To check the latest revision, please refer to the Intersil website at <http://www.intersil.com/design/packages/index.asp>

All Intersil U.S. products are manufactured, assembled and tested utilizing ISO9000 quality systems. Intersil Corporation's quality certifications can be viewed at [www.intersil.com/design/quality](http://www.intersil.com/design/quality)

Intersil products are sold by description only. Intersil Corporation reserves the right to make changes in circuit design, software and/or specifications at any time without notice. Accordingly, the reader is cautioned to verify that data sheets are current before placing orders. Information furnished by Intersil is believed to be accurate and reliable. However, no responsibility is assumed by Intersil or its subsidiaries for its use; nor for any infringements of patents or other rights of third parties which may result from its use. No license is granted by implication or otherwise under any patent or patent rights of Intersil or its subsidiaries.

For information regarding Intersil Corporation and its products, see [www.intersil.com](http://www.intersil.com)